

# Washer Sizing Chart

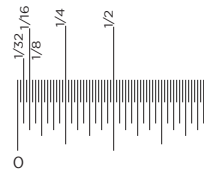

These drawings are actual size. Make sure your printer does not scale when printing. To check, measure the inch scale to the right.



## Top Cap Washers: "Quiet Black"

1/8"

**700502**  
Trumpet.  
Fits Bach & others.  
(3.17mm x 9.92mm x 17.46mm)

3/32"

**700609**  
Trumpet. A400 Size, 530.  
Fits Holton & Bundy & others.  
(2.38mm x 11.11mm x 17.46mm)

5/64"

**700611**  
Trumpet. A401 Size.  
Fits Olds and others.  
(1.98mm x 10.31mm x 17.46mm)

3/32"

**700613**  
Trumpet. A402 Size.  
Fits Conn, King, Yamaha & others.  
(2.38mm x 9.52mm x 18.25mm)

1/16"

**700615**  
Trumpet. A403 Size.  
Fits Getzen & others.  
(1.59mm x 9.52mm x 17.46mm)

1/8"

**700617**  
Baritone Horn. A404 Size.  
Fits Holton & others.  
(3.17mm x 10.31mm x 19.05mm)

1/16"

**700619**  
Sousaphone. A406 Size.  
Fits King & others.  
(1.59mm x 14.28mm x 22.33mm)

5/64"

**700621**  
Sousaphone. A407 Size.  
Fits Holton and others.  
(1.98mm x 9.52mm x 20.63mm)

3/32"

**700623**  
Trumpet. A416 Size.  
Fits Leblanc, Selmer & others.  
(2.38mm x 9.12mm x 15.08mm)

3/32"

**700625**  
Fits most makes.  
(2.38mm x 5.15mm x 14.28mm)

1/16"

**700627**  
Trumpet. Fits Schilke.  
(1.59mm x 10.31mm x 16.66mm)

3/32"

**700629**  
Trumpet. Fits Conn, King, Yamaha, & similar.  
(2.38mm x 9.52mm x 18.25mm)

.103"

**700633**  
Trumpet. Fits Bach & others.  
(2.61mm x 9.92mm x 17.46mm)

.080"

**700635**  
Trumpet. Fits Yamaha YTR 2335, Jupiter CEB 660L, Bach Liberty, & similar.  
(2.03mm x 9.52mm x 18.25mm)

.105"

**700637**  
Trumpet. Fits Bundy, BTR-300, King TPT-600, & similar.  
(2.67mm x 9.52mm x 18.25mm)

.070"

**700639**  
Trumpet. Fits Eastman ETR-400 & similar.  
(1.78mm x 9.52mm x 18.25mm)

.085"

**700641**  
Trumpet. Fits Bach TR-30H & similar.  
(2.16mm x 11.11mm x 17.46mm)

.110"

**700650**  
Baritone.  
(2.80mm x 12.70mm x 22.33mm)

.085"

**700739**  
Trumpet.  
(2.16mm x 9.52mm x 18.25mm)

.090"

**700740**  
Trumpet.  
(2.29mm x 9.52mm x 18.25mm)

.095"

**700741**  
Trumpet.  
(2.41mm x 9.52mm x 18.25mm)

.090"

**700743**  
Flugel.  
(2.29mm x 9.52mm x 18.25mm)

## Valve Stem Washers: "Quiet Black"



700561  
Jupiter  
(3.17mm x 5.55mm x 12.70mm)



700563  
(2.38mm x 5.55mm x 12.70mm)

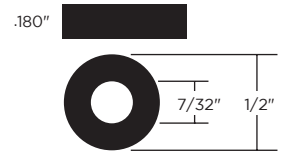

700592  
(4.57mm x 5.55mm x 12.70mm)

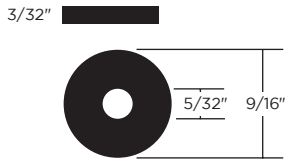

700601  
A410 Size.  
Fits most makes.  
(2.38mm x 3.96mm x 14.28mm)

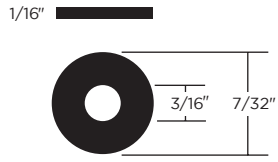

700603  
A412 Size.  
Fits other makes.  
(1.59mm x 4.76mm x 5.55mm)

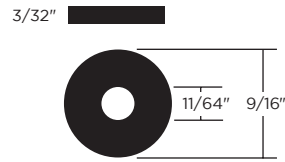

700605  
A413 Size.  
Fits baritone horn.  
(2.38mm x 4.36mm x 14.28mm)

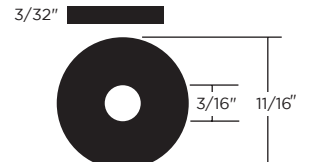

700607  
A415 Size.  
Fits sousaphone.  
(2.38mm x 4.76mm x 17.46mm)



700643  
Fits Yamaha YTR-  
2335 and similar.  
(2.54mm x 5.55mm x 12.70mm)



700645  
Fits Jupiter CEB  
660L & similar.  
(2.16mm x 5.15mm x 14.28mm)



700647  
Fits Bach Liberty & similar.  
(2.67mm x 4.76mm x 13.49mm)

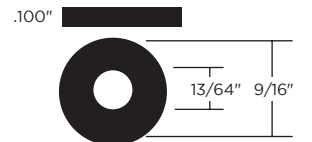

700649  
Fits Bundy BTR-300/King  
TPT-600 & similar.  
(2.54mm x 5.15mm x 14.28mm)

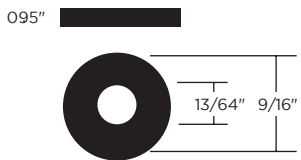

700691  
Fits Eastman  
ETR-400 & similar.  
(2.41mm x 5.15mm x 14.58mm)

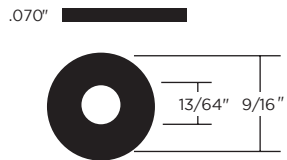

700693  
Fits Bach TR-300H & similar.  
(1.78mm x 5.15mm x 14.28mm)

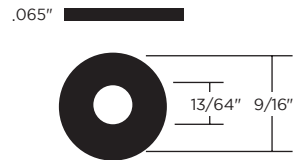

700695  
Fits Holton T602P TPTT & similar.  
(1.65mm x 5.15mm x 14.28mm)



700698  
Fits Jupiter Sousaphone.  
(2.79mm x 6.35mm x 18.65mm)



700736  
Trumpet.  
(2.16mm x 6.35mm x 14.28mm)

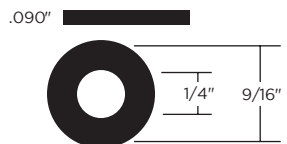

700737  
Trumpet.  
(2.29mm x 6.35mm x 14.28mm)



700738  
Trumpet.  
(2.41mm x 6.35mm x 14.28mm)



700742  
Flugel.  
(1.65mm x 6.35mm x 14.28mm)



700752  
Trumpet.  
(2.54mm x 6.35mm x 14.28mm)

## Valve Stem Washers: "Firm Red"

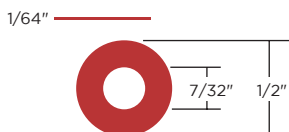

700585  
(.40mm x 5.55mm x 12.70mm)



700587  
(.79mm x 5.55mm x 12.70mm)

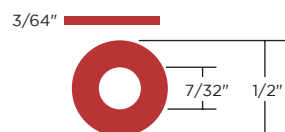



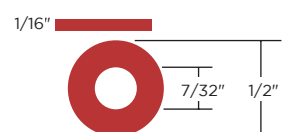

700589  
(1.19mm x 5.55mm x 12.70mm)

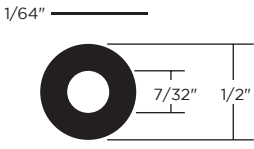

700591  
(1.59mm x 5.55mm x 12.70mm)

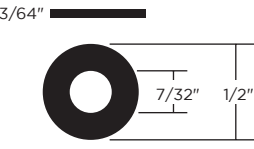
## Valve Stem Washers: “Firm Black”

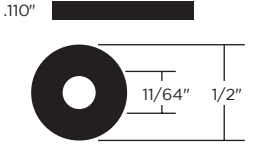
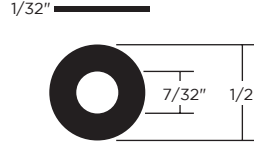
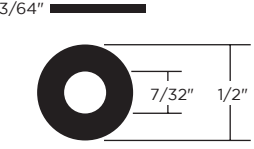
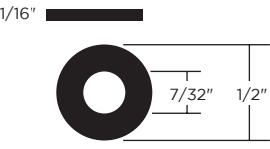
 <p>1/64" ———</p> <p>7/32" 1/2"</p> <p>700577 (.40mm x 5.55mm x 12.70mm)</p>	 <p>1/32" ———</p> <p>7/32" 1/2"</p> <p>700579 (.79mm x 5.55mm x 12.70mm)</p>	 <p>3/64" ———</p> <p>7/32" 1/2"</p> <p>700581 (1.19mm x 5.55mm x 12.70mm)</p>	 <p>1/16" ———</p> <p>7/32" 1/2"</p> <p>700583 (1.59mm x 5.55mm x 12.70mm)</p>
 <p>.110" ———</p> <p>11/64" 1/2"</p> <p>700595 (2.80mm x 4.36mm x 12.70mm)</p>	 <p>1/32" ———</p> <p>7/32" 1/2"</p> <p>700571 (.79mm x 5.55mm x 12.70mm)</p>	 <p>3/64" ———</p> <p>7/32" 1/2"</p> <p>700573 (1.19mm x 5.55mm x 12.70mm)</p>	 <p>1/16" ———</p> <p>7/32" 1/2"</p> <p>700575 (1.59mm x 5.55mm x 12.70mm)</p>

## Valve Stem Washers: “Firm Cork”

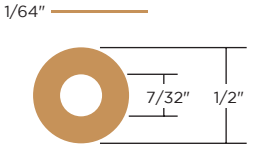
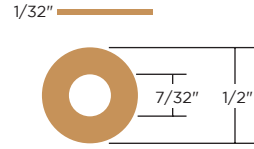
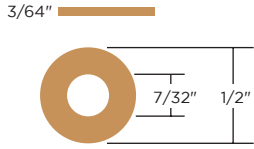
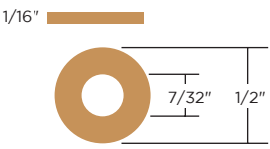
 <p>1/64" ———</p> <p>7/32" 1/2"</p> <p>700553 (.40mm x 5.55mm x 12.70mm)</p>	 <p>1/32" ———</p> <p>7/32" 1/2"</p> <p>700555 (.79mm x 5.55mm x 12.70mm)</p>	 <p>3/64" ———</p> <p>7/32" 1/2"</p> <p>700557 (1.19mm x 5.55mm x 12.70mm)</p>	 <p>1/16" ———</p> <p>7/32" 1/2"</p> <p>700559 (1.59mm x 5.55mm x 12.70mm)</p>
---	--	--	---

## Critical Alignment Washers:

### Upstroke

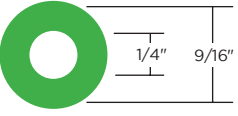
 <p>.001" ———</p> <p>.002" ———</p> <p>.003" ———</p> <p>.004" ———</p> <p>1/4" 9/16"</p> <p>40514 -specify thickness (.02mm, .05mm, .08mm, .10mm) (6.35mm x 14.28mm)</p>
--

### Downstroke

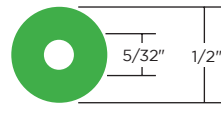
 <p>.001" ———</p> <p>.002" ———</p> <p>.003" ———</p> <p>.004" ———</p> <p>5/32" 1/2"</p> <p>40511 -specify thickness (.02mm, .05mm, .08mm, .10mm) (3.96mm x 12.70mm)</p>
---

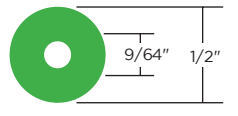
 <p>.001" ———</p> <p>.002" ———</p> <p>.003" ———</p> <p>.004" ———</p> <p>9/64" 1/2"</p> <p>40512 -specify thickness (.02mm, .05mm, .08mm, .10mm) (3.57mm x 12.70mm)</p>
---

## Q Felt Washers:

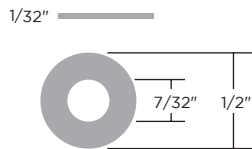

700756  
(0.79mm x 5.55mm x 12.70mm)

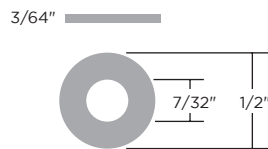

700757  
(1.19mm x 5.55mm x 12.70mm)

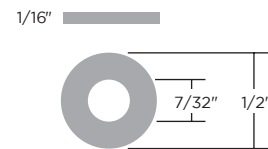

700758  
(1.59mm x 5.55mm x 12.70mm)

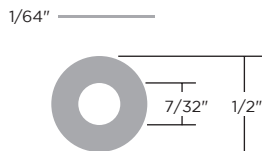

700759  
(0.39mm x 5.55mm x 12.70mm)

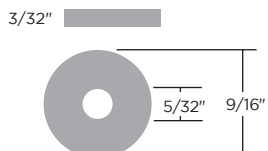

700760  
(2.38mm x 3.96mm x 14.28mm)

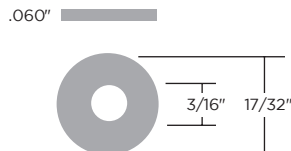

700761  
(1.52mm x 4.76mm x 13.49mm)

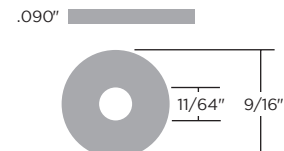

700762  
(2.28mm x 4.36mm x 14.28mm)

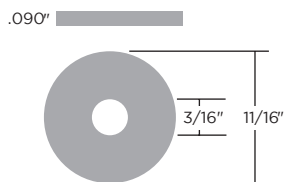

700763  
(2.28mm x 4.765mm x 17.46mm)

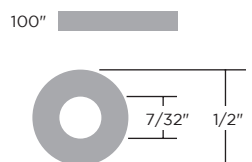

700776  
(2.54mm x 5.55mm x 12.70mm)

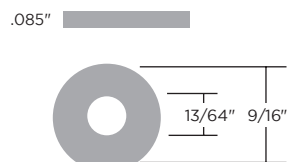

700777  
(2.15mm x 5.15mm x 14.28mm)

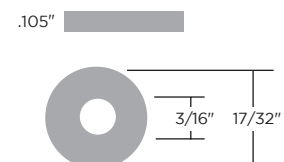

700778  
(2.66mm x 4.76mm x 13.49mm)

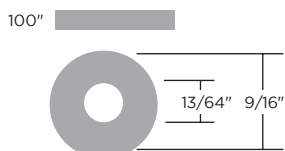

700779  
(2.54mm x 5.15mm x 14.28mm)

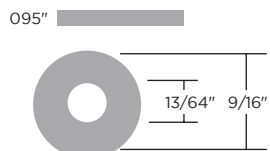

700780  
(2.41mm x 5.15mm x 14.28mm)

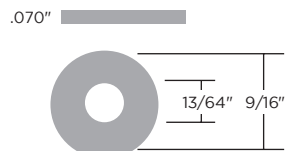

700781  
(1.77mm x 5.15mm x 14.28mm)

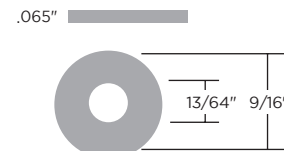

700782  
(2.79mm x 6.35mm x 18.65mm)

## Q2 Felt Washers:

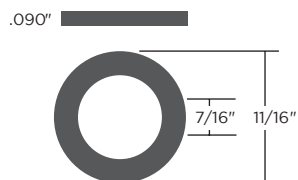

700764  
(2.38mm x 11.11mm x 17.46mm)

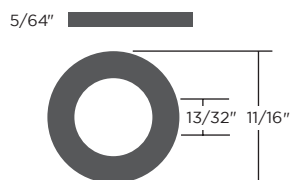

700765  
(1.98mm x 10.31mm x 17.46mm)



700766  
(2.38mm x 9.52mm x 18.25mm)

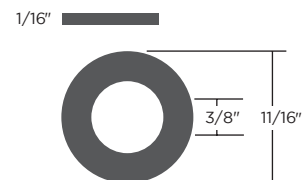

700767  
(1.58mm x 9.52mm x 17.46mm)

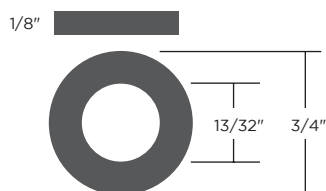

700768  
(3.17mm x 10.31mm x 19.05mm)

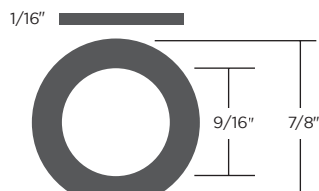

700769  
(1.58mm x 14.28mm x 22.22mm)

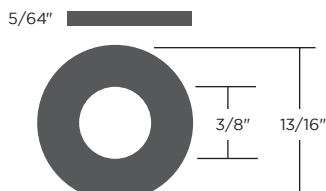

700770  
(1.98mm x 9.52mm x 20.63mm)

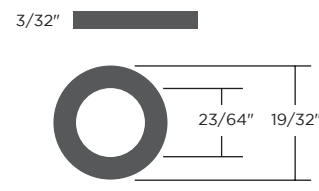

700771  
(2.38mm x 9.12mm x 15.08mm)

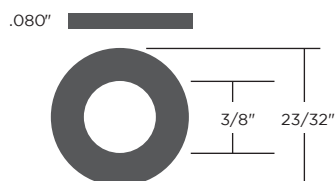

700772  
(2.03mm x 9.52mm x 18.25mm)

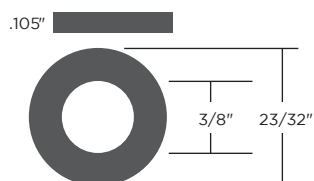

700773  
(2.66mm x 9.52mm x 18.25mm)

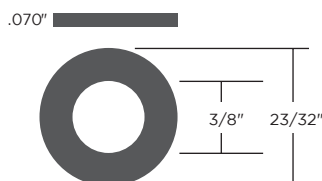

700774  
(1.77mm x 9.52mm x 18.25mm)

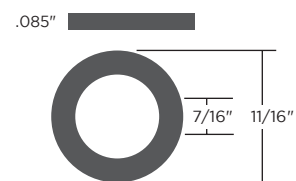

700775  
(2.15mm x 11.11mm x 17.465mm)